

KHG

Hochdruck-Kugelhahn mit Gewindeanschluß
 High pressure ball valve with threaded ports
 Robinet haute pression à boisseau sphérique, raccords mâles ou femelles

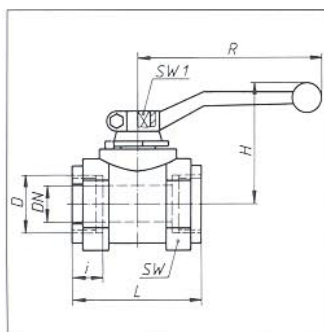

● Der Schaltgriff gehört zum Lieferumfang.

● Bei Kugelhähnen mit Dichtungen aus Teflon werden im Normalfall O-Ringe aus Viton eingebaut.

● Sonderausführungen auf Anfrage.

● The handle is included.

● Ball valves with teflon seals are normally delivered with viton O-rings.

● Special designs upon request.

● La manette est comprise dans la livraison.

● Les robinets à boisseau sphérique avec joints teflon, sont prévus normalement avec joints torique en viton.

● Exécutions spéciales sur demande.

Bestell-Nr. und Typ bitte angeben.

Please quote order-no. and typ.

Mentionner référence et type s.v.p.

Typ 1
Typ 2



KHG V 500.104 /...

	PN bar	DN mm	Normalausführungen Standard versions Exécutions standards	
			Typ 1	Typ 2
Gehäuse Body Corps	150-500	4-25	Stahl Steel Acier	Stahl Steel Acier
Kugel Ball Bille	150-500	4-25	Stahl, hartverchromt Steel, hard chromed Acier, chromé dur	Stahl, hartverchromt Steel, hard chromed Acier, chromé dur
Dichtungen Seals Joints	150-500	4-25	Polyamid	Teflon

Volldurchgang
Baulänge DIN 3202 V1, M3
DN 4- 25
PN 150-500

Full bore
Length, face-to-face DIN 3202 V1, M3
DN 4- 25
PN 150-500

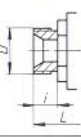
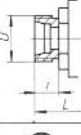
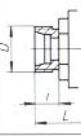
Passage intégral
Longueur hors tout DIN 3202 V1, M3
DN 4- 25
PN 150-500

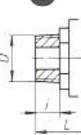
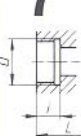
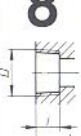
Anschlußart Type of connection Type de raccordement	DN	Rohr AD pipe OD ø ext. du tube	PN		D	i	L	SW	H	R	SW1	Gew. kg Weight kg Poids kg	Bestell-Nr. Order-No. Référence
			Polyamid	Teflon									
1 Für Rohrverschraubung mit Kugelbuchse, DIN 7601  For compression fitting, with ball-type nipple, DIN 7601 Pour raccord avec cône, DIN 7601	4	-	500	350	M 12x1,5	10	76	24	45	90	8	0,3	KHG V 500.104
	6	-	500	350	M 14x1,5	10	76	24	45	90	8	0,3	KHG V 500.106
	8	-	500	350	M 16x1,5	11	76	24	45	90	8	0,3	KHG V 500.108
	10	-	500	350	M 18x1,5	11	80	30	51	90	8	0,4	KHG V 500.110
	12	-	500	350	M 22x1,5	12	96	36	66	130	10	0,7	KHG V 500.112
	16	-	400	250	M 26x1,5	12	105	41	68	130	10	0,8	KHG V 400.116
	20	-	315	175	M 30x1,5	14	110	46	77	180	10	1,1	KHG V 315.120
	25	-	315	150	M 38x1,5	14	120	55	82	180	12	1,6	KHG V 315.125
2 Für Rohrverschraubung leichte Reihe, DIN 2353  For compression fitting, light series, DIN 2353 Pour raccord avec cône DIN 2353, série légère	4	6	250*	250*	M 12x1,5	10	76	24	45	90	8	0,3	KHG V 250.204
	6	8	250*	250*	M 14x1,5	10	76	24	45	90	8	0,3	KHG V 250.206
	8	10	250*	250*	M 16x1,5	11	76	24	45	90	8	0,3	KHG V 250.208
	10	12	250*	250*	M 18x1,5	11	80	30	51	90	8	0,4	KHG V 250.210
	12	15	250*	250*	M 22x1,5	12	96	36	66	130	10	0,7	KHG V 250.212
	16	18	160*	160*	M 26x1,5	12	105	41	68	130	10	0,8	KHG V 160.216
	20	22	160*	160*	M 30x2	14	110	46	77	180	10	1,1	KHG V 160.220
	25	28	100*	100*	M 36x2	14	120	55	82	180	12	1,6	KHG V 100.225
3 Für Rohrverschraubung schwere Reihe, DIN 2353  For compression fitting, heavy series, DIN 2353 Pour raccord avec cône DIN 2353, série lourde	4	8	500	350	M 16x1,5	12	76	24	45	90	8	0,3	KHG V 500.304
	6	10	500	350	M 18x1,5	12	76	24	45	90	8	0,3	KHG V 500.306
	8	12	500	350	M 20x1,5	12	76	24	45	90	8	0,3	KHG V 500.308
	10	14	500	350	M 22x1,5	14	80	30	51	90	8	0,4	KHG V 500.310
	12	16	400*	350	M 24x1,5	14	96	36	66	130	10	0,7	KHG V 400.312
	16	20	400	250	M 30x2	16	105	41	68	130	10	0,8	KHG V 400.316
	20	25	315	175	M 36x2	18	110	46	77	180	10	1,1	KHG V 315.320
	25	30	250*	150	M 42x2	20	120	55	82	180	12	1,6	KHG V 250.325
4 Flachdichtend, metrisches Außengewinde, DIN 13  Flat sealing metric male thread, DIN 13 Filet métrique mâle avec étanchéité, DIN 13	4	-	500	350	M 12x1,5	10	76	24	45	90	8	0,3	KHG V 500.404
	6	-	500	350	M 14x1,5	10	76	24	45	90	8	0,3	KHG V 500.406
	8	-	500	350	M 16x1,5	11	76	24	45	90	8	0,3	KHG V 500.408
	10	-	500	350	M 18x1,5	11	80	30	51	90	8	0,4	KHG V 500.410
	12	-	500	350	M 22x1,5	12	96	36	66	130	10	0,7	KHG V 500.412
	16	-	400	250	M 26x1,5	12	105	41	68	130	10	0,8	KHG V 400.416
	20	-	315	175	M 30x1,5	14	110	46	77	180	10	1,1	KHG V 315.420
	25	-	315	150	M 38x1,5	14	120	55	82	180	12	1,6	KHG V 315.425
5 Flachdichtend, Rohraußengewinde, DIN ISO 228/1  Flat sealing BSP male thread, DIN ISO 228/1 Filet whitworth mâle avec étanchéité, DIN ISO 228/1	4	-	500	350	G 1/8 A	10	76	24	45	90	8	0,3	KHG V 500.504
	6	-	500	350	G 1/4 A	11	76	24	45	90	8	0,3	KHG V 500.506
	8	-	500	350	G 3/8 A	12	76	24	45	90	8	0,3	KHG V 500.508
	10	-	500	350	G 1/2 A	12	80	30	51	90	8	0,4	KHG V 500.510
	12	-	500	350	G 5/8 A	12	96	36	66	130	10	0,7	KHG V 500.512
	16	-	400	250	G 3/4 A	14	105	41	68	130	10	0,8	KHG V 400.516
	20	-	315	175	G 1 A	16	110	46	77	180	10	1,1	KHG V 315.520
	25	-	315	150	G 1 1/4 A	18	120	55	82	180	12	1,6	KHG V 315.525
6 NPT-Außengewinde, ANSI/ASME B 1.20.1  NPT male thread, ANSI/ASME B 1.20.1 Filet mâle NPT, ANSI/ASME B 1.20.1	4	-	500	350	NPT 1/8	9,5	69	24	45	90	8	0,3	KHG V 500.604
	6	-	500	350	NPT 1/4	14,5	79	24	45	90	8	0,3	KHG V 500.606
	8	-	500	350	NPT 3/8	14,5	79	24	45	90	8	0,3	KHG V 500.608
	10	-	500	350	NPT 1/2	19	90	30	51	90	8	0,4	KHG V 500.610
	12	-	500	350	NPT 1/2	19	110	36	66	130	10	0,7	KHG V 500.612
	16	-	400	250	NPT 3/4	19	112	41	68	130	10	0,8	KHG V 400.616
	20	-	315	175	NPT 1	24	125	46	77	180	10	1,2	KHG V 315.620
	25	-	315	150	NPT 1 1/4	24,5	141	55	82	180	12	1,7	KHG V 315.625
7 Rohringengewinde, DIN ISO 228/1  BSP female thread, DIN ISO 228/1 Taraudage, whitworth DIN ISO 228/1	4	-	500	350	G 1/8	11	50	24	45	90	8	0,3	KHG V 500.704
	6	-	500	350	G 1/4	12,5	50	24	45	90	8	0,3	KHG V 500.706
	8	-	500	350	G 3/8	12,5	55	28	45	90	8	0,3	KHG V 500.708
	10	-	500	350	G 3/8	12,5	60	30	51	90	8	0,4	KHG V 500.710
	12	-	500	350	G 1/2	15	75	36	66	130	10	0,6	KHG V 500.712
	16	-	400	250	G 1/2	15	75	41	68	130	10	0,7	KHG V 400.716
	20	-	315	175	G 3/4	18	80	46	77	180	10	0,8	KHG V 315.720
	25	-	315	150	G 1	20	90	55	82	180	12	1,2	KHG V 315.725
8 NPT-Innengewinde, ANSI/ASME B 1.20.1  NPT female thread, ANSI/ASME B 1.20.1 Taraudage NPT, ANSI/ASME B 1.20.1	4	-	500	350	NPT 1/8	11	50	24	45	90	8	0,3	KHG V 500.804
	6	-	500	350	NPT 1/4	12,5	50	24	45	90	8	0,3	KHG V 500.806
	8	-	500	350	NPT 3/8	12,5	55	28	45	90	8	0,3	KHG V 500.808
	10	-	500	350	NPT 3/8	12,5	60	30	51	90	8	0,4	KHG V 500.810
	12	-	500	350	NPT 1/2	15	75	36	66	130	10	0,6	KHG V 500.812
	16	-	400	250	NPT 1/2	15	75	41	68	130	10	0,7	KHG V 400.816
	20	-	315	175	NPT 3/4	18	80	46	77	180	10	0,8	KHG V 315.820
	25	-	315	150	NPT 1	20	90	55	82	180	12	1,2	KHG V 315.825

* Druckstufe der Rohrverschraubung.
 Do not exceed nominal pipe pressure. Veuillez vous reporter à la pression nominale du tube.