

SOLENOID DIAPHRAGM PUMP 204.1



PUMP TYPE

R 204.1 - 1,2e	C 204.1 - 1,2e
R 204.1 - 2,4e	C 204.1 - 2,4e
R 204.1 - 7,0e	C 204.1 - 7,0e
R 204.1 - 10e	C 204.1 - 10e
R 204.1 - 35e	C 204.1 - 35e

i NOTE

Record the exact type and serial number here ► can be read off the type plate on the pump.
These data are important in the case of queries or for ordering spare and/or wear parts and must always be stated.

TYPE:

SERIAL NO:

i NOTE

Keep the operating manual for future use!

! ATTENTION

Subject to technical modifications!

Quality notes

The **sera** quality management and quality assurance system is certified in accordance with DIN EN ISO 9001:2015.
The **sera** product complies with the applicable safety requirements and accident prevention regulations.

About this instructions

Special notes in these instructions are marked with text and danger symbols.

NOTE

Notes or instructions that facilitate work and ensure a safe operation.

ATTENTION

The non-observance of these safety instructions can result in malfunctions or material damages.

WARNING

The non-observance of these safety instructions can lead to material damages and personal injuries.



Note on the additional instructions „SAFETY INSTRUCTIONS“.

These technical manual is divided into the following main parts:

TRANSPORT & STORAGE	page 6
PRODUCT DESCRIPTION	page 7
TECHNICAL DATA	page 11
ASSEMBLY / INSTALLATION	page 15
START-UP	page 22
ELECTRICAL CONNECTIONS	page 22
MAINTENANCE	page 23
FFAULT ANALYSIS / CORRECTIVE ACTION	page 26
SHUT-DOWN / DISPOSAL	page 26
CLEARANCE CERTIFICATE	page 29

Depending on the pump type (see order confirmation) the following additional instructions are included:

Control C204.1	TM10
Control R204.1	TM12
Control C204.1 PROFIBUS	TM13

TRANSPORT & STORAGE	6
General	6
Storage.....	6
PRODUCT DESCRIPTION	7
Type key	7
Type plate	8
Notes attached to the product.....	8
Materials	8
Components of the pump	9
TECHNICAL DATA	11
NOISE MEASUREMENT	13
VISCOSITY, PUMPED MEDIUM.....	13
TEMPERATURE DATA	13
AMBIENT CONDITIONS	13
Characteristics	13
Dimensions.....	14
ASSEMBLY / INSTALLATION	15
START-UP / ELECTRICAL CONNECTIONS	22
MAINTENANCE	23
Overview of the tightening torques.....	23
Changing the diaphragm	23
Spare and wear parts.....	24
FFAULT ANALYSIS / CORRECTIVE ACTION	26
SHUT-DOWN / DISPOSAL	28
Shut-down	28
Disposal.....	28
CLEARANCE CERTIFICATE	29



WARNING

Observe and follow the safety instructions by all means.
See the additional instructions „SAFETY INSTRUCTIONS“.
Man, machine and environment are endangered if the safety instructions are not observed.



General

sera products are checked for perfect condition and function previous to shipment.
Check for transport damage immediately after arrival of goods. If damage is found, this is to be reported immediately to the responsible carrier and the manufacturer.

Storage

An undamaged packaging protects the unit during storage and should only be opened when the product is installed.
Proper storage increases the service life of the product and includes prevention of negative influences such as heat, moisture, dust, chemicals etc.

The following storage specifications are to be observed:

- Storage place: cool, dry, dustfree and slightly ventilated
- Storage temperature and relative air humidity see Chapter „TECHNICAL DATA“.
- The maximum storage time for the standard packaging is 12 months.

If these values are exceeded, metal products should be sealed in foil and protected from condensation water with a suitable desiccant.

Do not store solvents, fuels, lubricants, chemicals, acids, disinfectants and similar in the storage room.

Type key

Type of drive (combinations possible)

- C controllable
- M not adjustable
- R adjustable
- F Motor suitable for frequency converter operation
- i Frequency converter, mounted on the motor
- K Stroke mechanism with side drive shaft and connected to the drive via a clutch
- Z twin design
- X Stroke mechanism with two opposite pump heads, combined suction and pressure side
- Y Stroke mechanism with two opposite pump heads

Series

- 204 (solenoid driven pumps)
- 409 (motor driven pumps)
- 410 (motor driven pumps)
- 509 (motor driven pumps)

Revision index

max. Nominal capacity (litre/hour (each pump head))

Displacer (type of construction)

- e Single diaphragm
- ML Multi-layer diaphragm
- KM Piston diaphragm
- K Piston

Type of control

Pro+

1

2

3

4

5

6

C

204

.

1

-

1,2

e

(example)

PRODUCT DESCRIPTION

Type plate

Each **sera** pump is factory provided with a type plate. The following information can be found on this type plate.

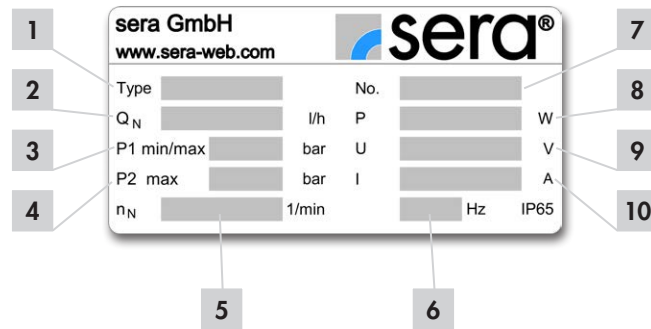

No.	Designation
1	Pump type
2	Nominal flow rate Delivery volume of the pump at rated pressure with media similar to water.
3	Minimum/maximum permissible pressure in the pump inlet Minimum/maximum permissible pressure in the inlet cross section which the pump can be used for. Please consider that pressure depends on rotation speed, flow rate, temperature and static pressure at the inlet.
4	Maximum permissible pressure in the pump outlet Maximum permissible pressure in the outlet cross section which the pump can be used for. Please consider that pressure depends on rotation speed, flow rate, temperature and static pressure at the outlet.
5	Nominal stroke frequency
6	Rated frequency
7	Serial number of the pump
8	Max. power consumption
9	Max. operating voltage
10	Max. current consumption

Notes attached to the product

Symbols which are directly attached to the pump, e.g. arrows for direction of rotation or symbols for fluid connections are to be observed and kept in legible condition.

Materials

The materials used are stated in the order confirmation and the product description..

sera pumps are run-dry safe oscillating displacement pumps that are characterised by high tightness of the dosing head. The fluid is conveyed by a deformable diaphragm. The flow capacity of the solenoid diaphragm pump can be controlled manually via the stroke length adjustment 0...100% and / or stroke frequency adjustment 0...100%.

Components of the pump

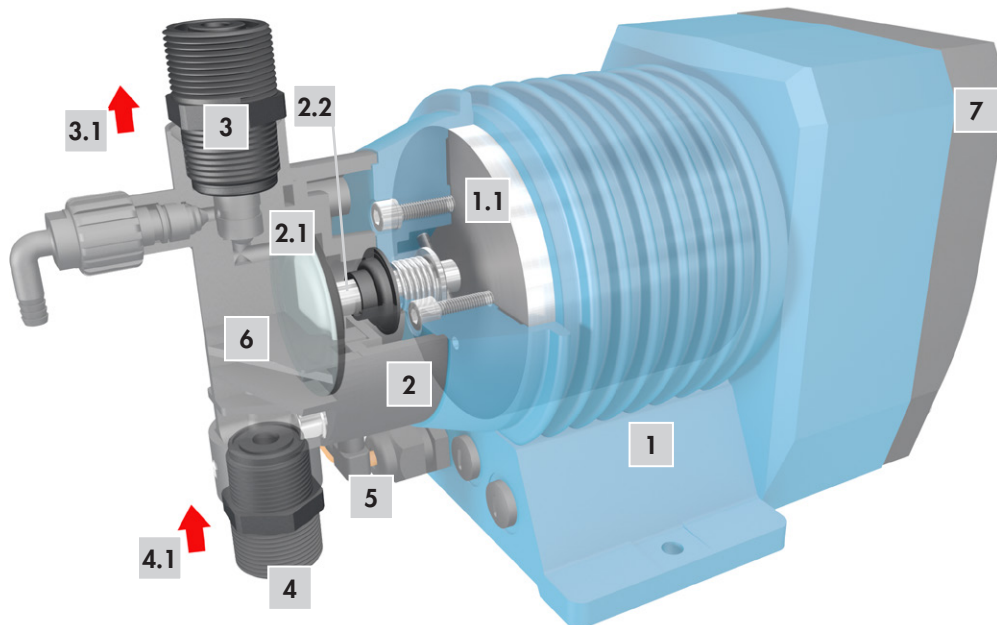

Motor housing (1) / Assembly pump (2)

The liquid is conveyed by a deformable drive diaphragm (2.1). This drive diaphragm is connected to the drive magnet (1.1) via a connecting rod (2.2) which results in a deflection of the suction and pressure stroke.

Pressure valve (3) / Suction valve (4)

The pump valves are always ball valves which can only function properly when they are installed in a vertical position. The condition of the valves is decisive for the operational behaviour of the pump. The valves should only be exchanged completely. Pay attention to the flow direction when installing the valves (3.1/4.1).

ATTENTION

Pressure valve above, suction valve below!

Diaphragm rupture monitoring device C204.1 (5)

sera solenoid diaphragm pumps of the C204.1 series are equipped with a conductive diaphragm rupture monitoring device.

NOTE

The sensitivity of the diaphragm rupture electrode can be adapted to the conductivity of the medium via the electronics (see the technical manual of the control). Preset ex works to 50% approx. 10 µS/cm.

ATTENTION

Maintenance of the diaphragm rupture electrode (MBE) is limited to cleaning when the diaphragm is exchanged. The MBE must be replaced if it was destroyed by the pumped medium.

PRODUCT DESCRIPTION

Pump body (6)

Depending on the applied backpressure, movements of the plastic pump body in elastic materials are possible. This does not affect the pumps's service life or operational reliability.

Manual vent valve (only FRP-execution C 204.1-1,2e - ... -10e)

The vent valve is used to release the manual pressure in the pump body (4) during commissioning. Open vent valve when pump primes first time.

When vent valve is opened gas including medium escapes into the feedback line. The vent valve must be closed again as soon as only medium without gas constituent escapes. The pump now feeds the medium into the pressure line.

Open again for another ventilation. The vent valve consists of a vent screw (6.1) with integrated hose nozzle (6.2), which must be fitted with a hose (6.3) (inside diameter 6 mm) as feedback line. The leaking medium incl. the gas admixtures must be disposed off properly.

The vent screw is inserted during normal operation

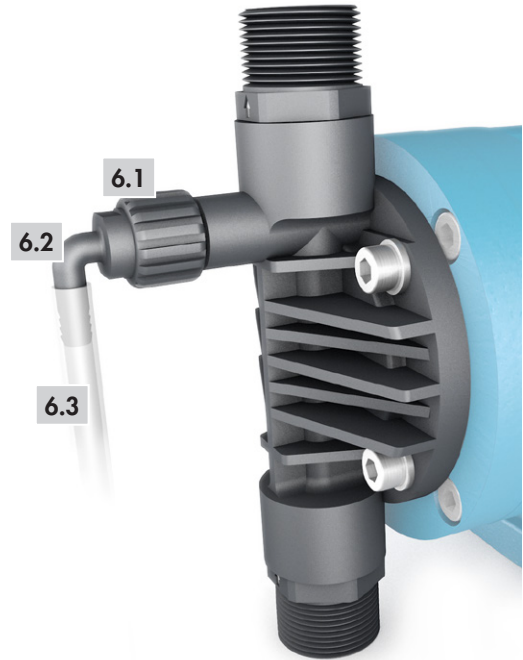

ATTENTION

Open vent screw with great caution and perform max. 1 turn. Take care that the tightness of the thread is still guaranteed.

ATTENTION

The vent screw must always be closed during the driving process.

Control (7)

NOTE

See the technical manual of the control!

R204.1

The electronics enable, among others, the proportional dosing via analog signals 4 ... 20mA. The three LEDs serve for indicating warning signals, errors and the current status of the dosing pump. An indicator "empty" along with pre-alarm and dry run indicators is installed as standard.

C204.1

The electronics permit proportional volumetric dosing via analogue signals 0/4 ... 20 mA or contact signals with the option of dividing or duplicating the pulse. An integrated LCD display and three LED's for warning and fault display indicate the current status of the dosing pump. A connection for flow monitoring or flow measurement as well as an empty signal with pre-alarm and dry operation alarm are installed as standard.

PUMP DATA			R 204.1-...				
			1,2e	2,4e	7,0e	10e	35e
Permissible pressure p_{2max} at the pump outlet	bar		10	10	10	6	1,5
Nominal capacity QN at p_{2max}	l/h	50/60 Hz	0-1,2	0-2,4	0-7	0-10	0-35
Quantity per stroke	ml/stroke	(100%)	0,13	0,27	0,78	1,11	3,89
Max. suction height	mWC		2	2	3	3	3
Min./max. permissible pressure at the pump inlet	bar	$p_{1min/max}$	0,2/0	-0,2/0	-0,3/0	-0,3/0	-0,3/0
Recommended nominal diameter DN of the connecting pipes	mm		5	5	5	5	10
Nominal stroke frequency	1/min	50/60 Hz	150	150	150	150	150
Weight approx.	kg		4,1	4,1	4,8	4,8	5,1

PUMP DATA			C 204.1-...				
			1,2e	2,4e	7,0e	10e	35e
Permissible pressure p_{2max} at the pump outlet	bar		10	10	10	6	1,5
Nominal capacity QN at p_{2max}	l/h	50/60 Hz	0-1,2	0-2,4	0-7	0-10	0-35
Quantity per stroke	ml/stroke	(100%)	0,13	0,27	0,78	1,11	3,89
Max. suction height	mWC		2	2	3	3	3
Min./max. permissible pressure at the pump inlet	bar	$p_{1min/max}$	-0,2/0	-0,2/0	-0,3/0	-0,3/0	-0,3/0
Recommended nominal diameter DN of the connecting pipes	mm		5	5	5	5	10
Nominal stroke frequency	1/min	50/60 Hz	150	150	150	150	150
Weight approx.	kg		4,1	4,1	4,8	4,8	5,1

TECHNICAL DATA

ELECTRICAL DATA		R 204.1-...e
Middle power draw	W	20
Nominal voltage	V	100 - 240
Frequency	Hz	50/60
Inlet voltage, control input	V DC	5...30
Minimum contact signal time	ms	55
Analogue input resistance	Ω	100
Current Consumption during stroke	A (at 230V)	max. 1,0
Recommended fuse	(circuit breaker)	C2A
Insulation class	ISO	F
Enclosure	IP	65

ELECTRICAL DATA		C 204.1-...e
Middle power draw	W	33
Nominal voltage	V	100 - 240
Frequency	Hz	50/60
Inlet voltage, control input	V DC	5...30
Minimum contact signal time	ms	55
Analogue input resistance	Ω	100
Current Consumption during stroke	A (at 230V)	max. 1,0
Digital output internal/external supply		PNP max. 15V DC, 50mA / max. 30V DC, 350mA
Recommended fuse	(circuit breaker)	C2A
Insulation class	ISO	F
Enclosure	IP	65

NOISE MEASUREMENT	
Max. sound pressure at max. burden	50 - 65 dB(A)

VISCOSITY, PUMPED MEDIUM	
Max. viscosity with non-spring-loaded valves	100 mPas (=cP)

TEMPERATURE DATA	
Max. liquid temperature	60 °C
Min. liquid temperature	10 °C
Max. operating temperature	40 °C
Min. operating temperature	0 °C
Max. storage temperature	40 °C
Min. storage temperature	0 °C

AMBIENT CONDITIONS	
Max. installation altitude above sea level	1000 m
Max. relative air humidity	< 90%

Characteristics

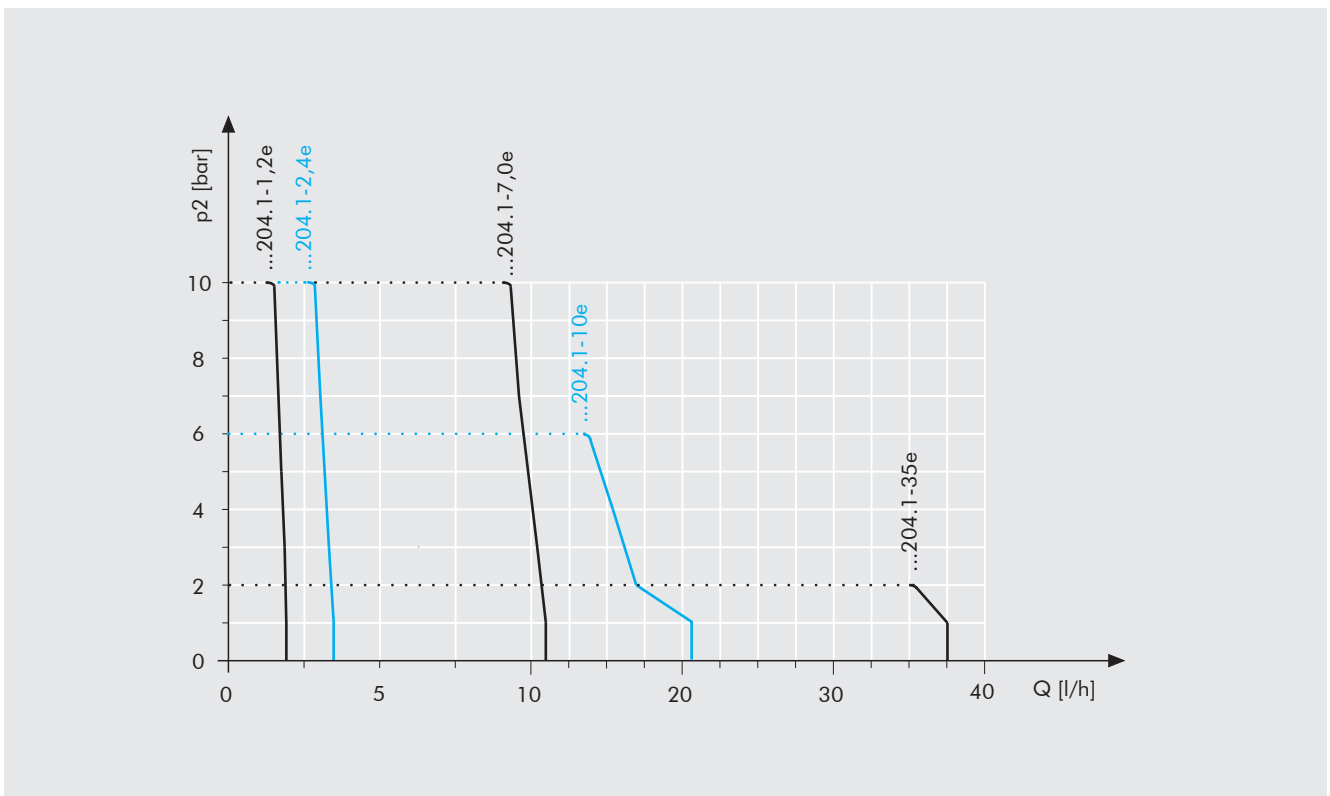

TECHNICAL DATA

Dimensions

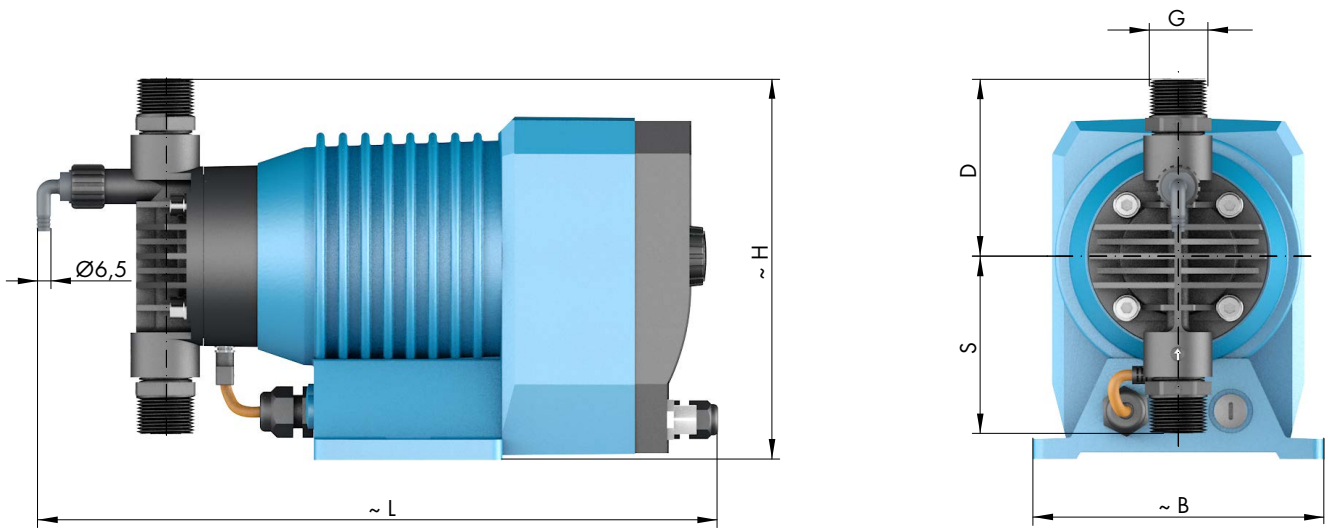

		...204.1-...				
SUCTION VALVES		...-1,2e	...-2,4e	...-7,0e	...-10e	...-35e
DN	Nominal width	5	5	5	5	10
G	Connection thread	G ^{3/4}	G ^{3/4}	G ^{3/4}	G ^{3/4}	G ^{3/4}
S	PP-FRP / PVDF-FRP	80	80	80	80	75
S	PVC-U	70	70	70	70	80
S	1.4571	70	70	70	70	76
PRESSURE VALVES		...-1,2e	...-2,4e	...-7,0e	...-10e	...-35e
DN	Nominal width	5	5	5	5	10
G	Connection thread	G ^{3/4}	G ^{3/4}	G ^{3/4}	G ^{3/4}	G ^{3/4}
D	PP-FRP / PVDF-FRP	80	80	80	80	75
D	PVC-U	70	70	70	70	80
D	1.4571	70	70	70	70	76
MAX. TOTAL HEIGHT		...-1,2e	...-2,4e	...-7,0e	...-10e	...-35e
H		175	175	175	175	175
MAX. TOTAL WIDTH		...-1,2e	...-2,4e	...-7,0e	...-10e	...-35e
B		130	130	130	130	130
MAX. TOTAL LENGTH		...-1,2e	...-2,4e	...-7,0e	...-10e	...-35e
L		275	275	275	275	275
L	(with vent valve)	305	305	305	305	—

(Measurements in mm)

**WARNING**

Observe and follow the safety instructions by all means.
See the additional instructions „SAFETY INSTRUCTIONS“.
Man, machine and environment are endangered if the safety instructions are not observed.

**NOTE**

Pump design data for dosing and its temperature can be found in the order confirmation.

**NOTE**

Operating conditions:
Ambient temperature, relative air humidity and max. installation altitude ► see chapter „Technical data“.

- The standard model of the pump is only approved for installation in dry areas in a non-aggressive atmosphere.
- Protect the pump from heat sources, direct sunlight and UV light.
- See “Dimensions” chapter for dimensions of the pump connections and fixing holes.
- Fixing the pump with at least four bolts above the pump base is required for safe operation.
- Install the pump so that there is no vibration and no tension and that it is aligned precisely.
- Install the pump at the optimum possible operating height. Mount the pump so that the valves are vertical.
- Ensure that there is sufficient space around the pump body and the suction and pressure valve so that these parts can be easily dismantled if required.
- Design the nominal diameters of the downstream piping and the valves installed in the system to be the same size or larger than the nominal inlet and outlet diameters of the pump.
- To check the pressure ratios in the piping system, it is recommended to provide connections for pressure measurement fittings (e.g. manometers) near the suction and pressure ports.
- Drain valves must be provided.
- Before connecting the pipes, remove the plastic caps on the suction and pressure ports of the pump.
- Check the fastening bolts for the pump body for tightness and tighten if necessary, see chapter “Overview of the tightening torques”.
- Connect pipes to the pump so that there are no forces acting on the pump, such as e.g. misalignment, weight or strain of the pipe.
- Keep the suction pipes as short as possible.
- Use pressure and medium resistant hoses / pipes.
- All pipes and containers connected to the pump must comply with the regulations and must be cleaned, tension-free and intact.
- Display devices must be easily accessible and readable.

In order to avoid cavitation, overload or excessive delivery, the following points should be noted:

- Avoid high suction heights.
- Keep pipes as short as possible.
- Select sufficiently large nominal diameters.
- Avoid unnecessary choke points.
- Install a pulsation damper.
- Install overpressure protection.
- Install a pressure-sustaining valve, if necessary
- Provide feed line for outgassing media.

**WARNING**

The pump with a control is only designed for operation outside Ex-zonest!

SUCTION SIDE (1)

The following fittings can be used on the suction side:

1.1 Line strainer



1.2 Suction aid
Siphon vessel



1.3 Suction lance

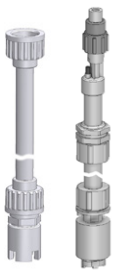

1.4 Multifunction device



1.5 Foot valve



1.6 Shut-off valve



PRESSURE SIDE (2)

The following fittings can be used on the pressure side:

2.1 Vent valve



2.2 Injection fitting

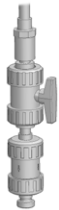

2.3 Dosing valve



2.4 Pulsation damper



2.5 Diaphragm pressure keeping valve



2.6 Diaphragm relief valve

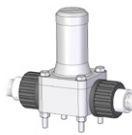

2.7 Multifunction valve



2.8 Flow meter

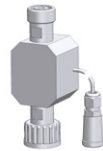

2.9 Flow monitor



2.10 Shut-off valve



SUCTION SIDE (1)

Line strainer (1.1)

Connect suction line slightly above the bottom of the tank and install a line strainer (0.1 – 0.5 mm mesh size – depending on valve nominal diameter of the pump).



ATTENTION

If impurities are not removed, this results in malfunctions of the pump and the system.

Suction aid / siphon vessel (1.2)

For high tanks without connection on the bottom of the tank ► install suction aid / siphon vessel. Thereby, pay attention to accelerating pressures which may be generated in a long suction pipe.

Suction lance (1.3)

Install a suction lance for removal of chemicals from tanks and barrels.
The integrated foot valve prevents the backflow of the suctioned medium.
The suction lances are equipped with a level switch for „empty“ signal.

Multifunction device (1.4)

The multifunction device is installed in the suction side piping of the pump and is used for determination of the delivery rate of pumps under real operating conditions.
The device can be filled either using a pending tank volume (communicating container) or using a hand vacuum pump.

Foot valve (1.5)

To prevent running dry of the suction line ► install foot valve (check valve) at the end of the suction line.

PRESSURE SIDE (2)

Vent valve (2.1)

If air can be drawn in due to falling liquid level in the suction tank and at the same time delivered to a pressurised line or against a pressure-sustaining valve ► install vent valve in the pressure line.

NOTE

The delivery flow can be interrupted if there is air in the suction line!

Injection fitting (2.2)

Install an injection fitting that routes into a main line to prevent the backflow of the pumped medium in the dosing line.

WARNING

Unwanted mixing in the dosing line occurs if any possible backflow from the main line is not prevented.

Dosing valve (2.3)

Installation of the dosing valve prevents the liquid from the system to be treated being able to penetrate into the dosing line.

Pulsation damper (2.4)

Damping of the pulsation by installation of pulsation dampers if:

- a low-pulsation delivery flow is desired for process reasons,
- acceleration forces caused by the piping geometry must be removed.

Install pulsation damper as close as possible to the pump head.

If both pulsation damper and pressure-sustaining valve should be integrated, install the pressure-sustaining valve between pump and pulsation damper.

WARNING

Undamped acceleration forces can result in the following faults / damage:

- flow rate fluctuations
- dosing errors
- pressure surges
- valve shocks
- increased wear on the suction and pressure sides of the pump
- mechanical destruction of the pump
- leaks and valve shocks if the permissible maximum pressure on the pump pressure side is exceeded
- damage to the piping and its installed fittings

Diaphragm pressure-keeping valve (2.5)

If dosing into a main line with negative pressure ► install pressure-keeping valve in the dosing line.

ATTENTION

It must be ensured during the installation that excess delivery (due to positive pressure difference ($\geq > 1$ bar) between pressure and suction sides) is avoided.

Diaphragm relief valve (2.6)

If the permissible pressure in the system can be exceeded by closing any shut-off valve or by clogging of the line ► install diaphragm relief valve.

When using an external overflow valve, the following is applicable for the return line:

- Route the return line sloping downward into the storage tank which is under atmospheric pressure or into an open drainage channel.
- Or connect directly to the pump suction line, but only if there is no check valve in the suction line (e.g. foot valve of a suction lance).

ATTENTION

Shut-off valves must not be closed when the pump is running!

WARNING

An overpressure protection device (e.g. relief valve) must generally be provided if the permissible operating pressure can be exceeded.

ATTENTION

If the permissible operating pressure is exceeded and the pump is not equipped with overpressure protection, the pump will be damaged.

WARNING

The pumped medium can spray out if the pump is damaged.

Multifunction valve (2.7)

The multifunction valve provides the following functions:

- pressure-keeping valve function,
- overflow valve function,
- pressure relief function,
- venting.

The multifunction valve is mounted directly on the pump pressure port.

Flow meter (2.8)

For measurement and monitoring of the flow rate ► install flow meter.

The application range is restricted to media that are similar to water.

The flow meter is screwed upright on the pressure port of the pump and connected to the pump electronics via the input for flow monitoring.

Flow monitor (2.9)

To record the flow rate of the pump ► install flow monitor.

The application range is restricted to media that are similar to water.

The flow monitor is screwed upright on the suction port of the pump and connected to the pump electronics via the input for flow monitoring.

Start-up



WARNING

Observe and follow the safety instructions by all means.
See the additional instructions „SAFETY INSTRUCTIONS“.
Man, machine and environment are endangered if the safety instructions are not observed.



Adequate fastening at the pump foot and compliance with the operating parameters specified in the technical data are required for the operation of the pump.

Checks before every start-up:

- Check all connections for tightness.
- Tighten fixing bolts of the pump body with the specified tightening torques (see „Overview of the tightening torques“ chapter).
- Check of the electrical connections.
- Check of the mains voltage on the rating plate with the local conditions.

Electrical connections



WARNING

Observe and follow the safety instructions by all means.
See the additional instructions „SAFETY INSTRUCTIONS“.
Man, machine and environment are endangered if the safety instructions are not observed.



NOTE

Operating voltage range see chapter „TECHNICAL DATA“.



NOTE

The pump restarts in the selected operating mode with the specified parameters after switching on again or after restoration of the power supply following a power failure.



ATTENTION

The pump restarts in the selected operating mode with the specified parameters after switching on again or after restoration of the power supply following a power failure.

 **WARNING**

Observe and follow the safety instructions by all means.
 See the additional instructions „SAFETY INSTRUCTIONS“.
 Man, machine and environment are endangered if the safety instructions are not observed.



Check the following at regular intervals:

- Tight fit of piping.
- Tight fit of pressure and suction valve.
- Proper condition of the electrical connections.
- Tight fit of the screws for fastening the pump body (check this at least every three months).
- For the tightening torques of the mounting screws, please see Chapter „Overview of the tightening torques“.
- Additionally with motor pumps: Check oil level regularly (oil eye).

Overview of the tightening torques

...204.1-1,2e	5 Nm
...204.1-2,4e	5 Nm
...204.1-7,0e	5 Nm
...204.1-10e	5 Nm
...204.1-35e	6 Nm

Changing the diaphragm

In order to ensure a correct function of the diaphragm pump and to fulfil the required safety and protective provisions it is absolutely necessary to check and replace the diaphragms at regular intervals.

 **WARNING**

Solenoid diaphragm pump C204.1:
 Observe the instructions on the graphical display for the replacement of wear parts!

Replacement of the working diaphragm:

- Loosen suction and pressure lines of pump.
- Make a note of the current setting of the stroke length.
- Set stroke length to 0 %.
- Screw out fixing screws (1) of pump body (2) (take off with disks (3)).
- Remove pump body (with valves) to the front.
- Unscrew working diaphragm (4) from connecting rod (5).
- Screw new working diaphragm onto connecting rod.
- Set stroke length to 50 %.
- Put pump body onto base ring (6). Tighten fixing screws crosswise with correct torque (see Chapter „Overview of the tightening torques“).



ATTENTION

When mounting the pump body please note:
Pressure valve above; suction valve below (Consider the direction of the arrows on the valves)!

- Fix suction and pressure line.
- Reset original stroke length.
- Apply voltage.
- The solenoid diaphragm pump is ready for operation

Spare and wear parts

The following parts are considered as wear parts of the dosing pump:

- Diaphragm (Diaphragm kit)
- Insert (Diaphragm kit)
- Diaphragm rupture electrode ► C204.1
- Valves kit (included o-ring kit)
- O-ring kit

Depending on their use and period of use, wear parts must be replaced at regular intervals in order to ensure reliable functioning of the dosing pump.

sera recommends replacement of wear parts after 3000 operating hours or at least once per year.

In the event of premature diaphragm rupture caused by harsh operating conditions, switch off the dosing pump and replace the drive diaphragm (in accordance with „Diaphragm replacement“ chapter).

The following parts are considered as spare parts of the dosing pump:

- Pump body kit (included mounting kit)
- Mounting kit

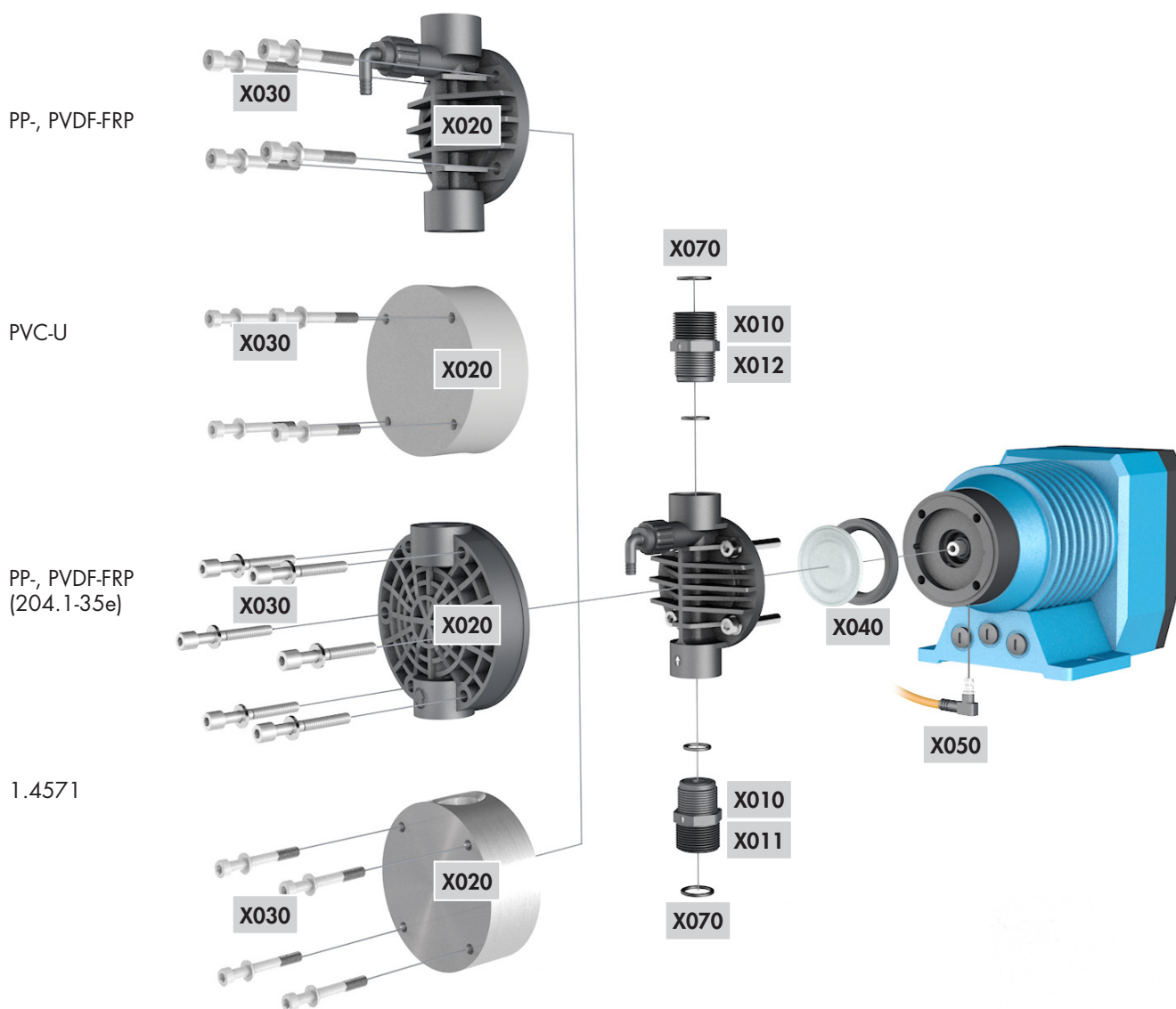

Pos.	Kit	Materials	consisting of
X010	Valves	PVC-U; PP-FRP; PVDF-FRP	Suction valve Pressure valve O-ring kit
X011	Suction valve	1.4571	Suction valve O-ring kit
X012	Pressure valve	1.4571	Pressure valve O-ring kit
X020	Pump body		Pump body Mounting kit
X030	Mounting		Screws, complete
X040	Diaphragm		Drive diaphragm Insert
X050	Diaphragm rupture electrode		Diaphragm rupture electrode ► C204.1
X070	O-rings		

FAULT ANALYSIS / CORRECTIVE ACTION

sera products are sophisticated technical products which are only shipped after having been thoroughly tested and checked at our factory.

Should there be any faults, these can be detected and rectified easily and quickly based the instructions in the tables.

i NOTE

Analysis of the error messages in the display for the pumps with a control ► see the operation instructions of the control!

Corrective action!	Fault type	Possible cause	Corrective action
Display, LED not lit! ► Pump with control			
Motor does not start! ► diaphragm pump			
Damage to stroke mechanism / drive!			
Pump does not draw in!	■ ■ ■		
Pump does not deliver!	■ ■ ■		
Flow rate is not reached!	■ ■ ■		
Delivery head is not reached!	■ ■ ■ ■ ■		
Flow rate fluctuates!	■ ■ ■ ■ ■		
Maximum permissible flow rate exceeded!			
Pipe oscillates heavily!			
Too high noise development!			
Service life of the drive diaphragm too low!			
Drive is overloaded (periodically occurring noises)!			
Leakage on pump head!			
		Suction height too high.	Reduce suction height or suction resistance.
		Suction pipe leaking.	Check seals, tighten pipe connections.
		Shut-off valves in piping closed.	Open shut-off valves or check opening state ► check pump for possible damage.
		No pumped medium in storage tank.	Fill storage tank.
		Pump valves leaking.	Remove and clean valves.
		Pump valves (ball seats) damaged.	Remove and clean valves, check function; replace valves if necessary.
		Pump valves incorrectly mounted or valve balls missing.	Check installation position and completeness ► replace missing parts or install correctly.
		Filter in suction line clogged.	Clean filter.
		Electrical data of the pump do not match mains data.	Check order data. Check electrical installation. Adjust motor to the network on site (for diaphragm pumps).
		Backpressure too high.	Measure pressure with manometer directly above pressure valve if possible and compare with permissible backpressure.
		Foreign matter in the pump valves.	Remove and clean valves.
		Pressure on suction side higher than at the end of the pressure pipe.	Check geodetic conditions, install float valve or pressure keeping valve if necessary.
		Acceleration height too high due to pipe geometry.	Check acceleration height on suction and pressure sides with manometer and compare with design data ► install a pulsation damper if necessary.
		Materials coming into contact with the medium not suitable for the pumped medium.	Check whether the pumped medium matches the design data and select other materials if necessary.

Fault type										Possible cause	Corrective action							
Pumpe läuft nicht!	Display, LED dunkel!	Pumpe mit Steuerung	Antriebsmotor läuft nicht an!	Motorpumpe	Schäden in Hubgetriebe / Antrieb!	Pumpe saugt nicht an!	Pumpe fördert nicht!	Förderstrom wird nicht erreicht!	Förderhöhe wird nicht erreicht!	Förderstrom ist schwankend!	Förderstrom größer als zulässig!	Rohrleitung schwingt sehr stark!	Geräuschentwicklung zu hoch!	Lebensdauer d. Antriebsmembrane zu gering!	Antrieb ist überlastet (periodisch auftretende Geräusche)!	Leckagen am Pumpenkopf!		
			■			■		■	■	■							Viscosity of the pumped medium too high.	Check viscosity of the pumped medium and compare with design data ► reduce concentration or increase temperature if necessary.
							■	■									Pumped medium is outgassing in the suction pipe and/or the pump body.	Check geodetic conditions and compare with data of the pumped medium. Operate pump with suction side supply, reduce temperature of the pumped medium.
						■											Air in suction line while pressure is present on the pressure side.	Vent pressure side.
■																	Power supply failed / switched off.	Restore power supply.
			■	■	■	■	■	■									Pipe connections leaking.	Tighten connections according to type of material. Be careful with plastic ► risk of fracture!!
			■	■													Pumped medium frozen in pipe.	Remove pump and check for possible damage - increase temperature of the pumped medium.
■	■					■											No mains power connection.	Connect mains power supply.
			■														Pump valves dry.	Moisten pump body and valves. Open vent valve.
			■	■	■										■		Temperature too low.	Check flowability of the dosing medium. Temperature of the medium see „Technical data“.
			■	■	■	■	■							■	■		Diaphragm rupture.	Replace the diaphragm according to the descriptions in Chapter „Replacing the diaphragm“.
■																	Reversible thermal fuse of the pump has tripped.	Let temperature of the pump cool down. Check ambient temperature.
	■																Fuse in electronics blown. ► Pump with control	Return pump for repair.
			■	■	■	■											Compensating valve not adjusted to operating conditions. ► diaphragm pump KM	Set compensating valve according to operating conditions. ► diaphragm pump KM
						■											Home position misadjusted ► 204.1	Reset stroke length ► 204.1



WARNING

Observe and follow the safety instructions by all means.
See the additional instructions „SAFETY INSTRUCTIONS“.
Man, machine and environment are endangered if the safety instructions are not observed.



Shut-down

- Switch off piston diaphragm pump.
- Rinse pump head and remove pumped medium; make sure that the rinsing agent is suitable for pumped medium and pump head.

Disposal

- Shut-down system. Please see “Shut-down”.

Dismantling and transport

- Shut-down system. Please see “Shut-down”.
- Remove all fluid residues from pump body, clean thoroughly, neutralize and decontaminate.
- Package unit and ship.



NOTE

A clearance certificate must be filled in when systems are returned to the manufacturer.
Acceptance will be rejected if this clearance certificate is not attached.

Complete disposal

- Remove all fluid residues from unit.
- Drain off lubricants and dispose of according to regulations!
- Dismount materials and send them to a suitable waste disposal company!

i NOTE

Inspection / repair of machines and machine parts is only carried out after the opposite clearance certificate was filled in correctly and completely by authorized and qualified personnel.

i NOTE

Acceptance will be refused if parts are returned to the manufacturer without a proper clearance certificate.

All industrial companies are obligated by the legal provisions for occupational health, e.g. the workplaces ordinances, the Ordinance on Hazardous Substances, the regulations for prevention of accidents and the environmental protection regulations such as the Waste Management Act and the German Household Water Act to protect their employees or man and the environment from detrimental effects when handling hazardous substances.

Should special safety precautions be necessary despite careful draining and cleaning of the product the necessary information are to be provided.

Machines which are operated with radioactive media shall only be inspected and/or repaired in the safety area of the owner by a **sera** specialized fitter.

The clearance certificate is part of the inspection-/repair order.
sera reserves the right to refuse acceptance of the order for other reasons.

i NOTE

Please make a copy and leave the original with the operating instructions!
(can also be downloaded from: www.sera-web.com)

Product

Type Serial-No.

the product was carefully emptied before shipping / delivery, and cleaned inside and outside. YES

Conveying medium











Designation Concentration %

Properties

Please tick!

 Harmless

If either of the listed properties, then enclose the appropriate safety and handling instructions.

<input type="checkbox"/> 	<input type="checkbox"/> 	<input type="checkbox"/> 	<input type="checkbox"/> 	<input type="checkbox"/> 
<input type="checkbox"/> 	<input type="checkbox"/> 	<input type="checkbox"/> 	<input type="checkbox"/> 	<input type="checkbox"/> 

The product was used with health or water-polluting substances and came up with labeling requirements and pollution prone media in contact. YES
 NO

Special security arrangements with respect to health or water-hazardous media are in the further handling not required
 required

The following safety precautions regarding rinsing, residual liquids and waste disposal are required:

Process data

The product was used with the following operating conditions described conveying medium:

Temperature °C Pressure bar

Sender

Company: Telephone:

Contact person: FAX:

Address: E-mail:

Zip code, City: Your order No:

We confirm that we have the information in this safety certificate (Clearance Certificate) have been correctly and completely and that the returned parts were carefully cleaned.

The parts are sent free of residues of dangerous amount.

Place, Date

Department

Signature
(and company stamp)

FOLLOW US



sera ProDos GmbH
sera-Str. 1
34376 Immenhausen
Germany
Tel. +49 5673 999 02
Fax +49 5673 999 03
info-prodos@sera-web.com
www.sera-web.com

TM11-01 EN 190109 sera® is a registered trademark of sera GmbH.
Technical details subject to change. sera shall not accept any liability for errors or omissions or for printing errors.